

KNEER · SÜD
FENSTER

Lived Vision



ENTRANCE DOORS
PRIME MODELS

2024

WOOD

PRIME MODELS 2024

Sophisticated front doors

The decisive factor for your well-considered purchase decision is certainly the appearance. The spark must jump over. Whether modern, classic, purist or charming - the front door must suit you and the style of your house. Wood front doors from KNEER-SÜDFENSTER are not only beautiful to look at and inviting, but also convince through inner values such as a robust construction, high security and good thermal insulation.

An innovative, technically mature front door fulfills its tasks for many years and looks very good at the same time!

ENTRANCE DOORS
CATEGORY **PREMIUM+**

FROM PAGE 6

ENTRANCE DOORS
CATEGORY **PREMIUM**

FROM PAGE 12

ENTRANCE DOORS
CATEGORY **BASIC**

PAGE 23

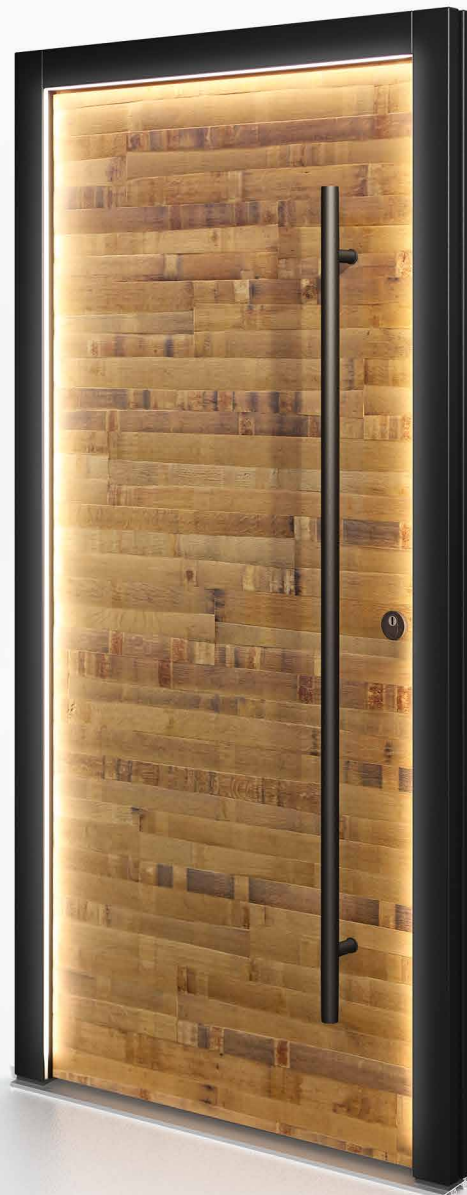

Welcome to Kneer-Südfenster

For 90 years the family business KNEER-SÜDFENSTER has been producing high-quality building elements for demanding clients from aluminum-wood, wood, aluminum, aluminum-plastic and plastic.

Around 800 employees manufacture windows, lift-and-slide doors, mullion-transom facades and entrance doors according to the latest findings in the highest quality for customers all over the world.



MODEL OVERVIEW	4
ENTRANCE DOORS MODELS	6
WOOD TYPES & COLOURS	24
GLAZING	25
HANDLE BARS	26
INTERIOR HANDLES & EXTERIOR ROSETTES	27
BLACK EQUIPMENT	28
SPECIAL EQUIPMENT	30
FINGERPRINT	31
SAFETY TECHNOLOGY	32
TECHNICAL DATA	34
ALSO AVAILABLE	38

MODEL OVERVIEW



HTA 24-337
> page 6



HTA 24-338
> page 8



HTA 24-350
> page 10



HTA 24-351
> page 10



HTA 24-301
> page 18



HTA 24-316
> page 18



HTA 24-333
> page 18



HTA 24-334
> page 18



HTA 24-302
> page 22



HTA 24-305
> page 22



HTA 24-321
> page 22



HTA 24-335
> page 22



HTA 24-327

> page 14



HTA 24-328

> page 15



HTA 24-329

> page 16



HTA 24-331

> page 17



HTA 24-307

> page 20



HTA 24-311

> page 20



HTA 24-318

> page 20



HTA 24-325

> page 20



HTA 24-340

> page 23



HTA 24-341

> page 23



HTA 24-342

> page 23



HTA 24-343

> page 23



RC 2
standard

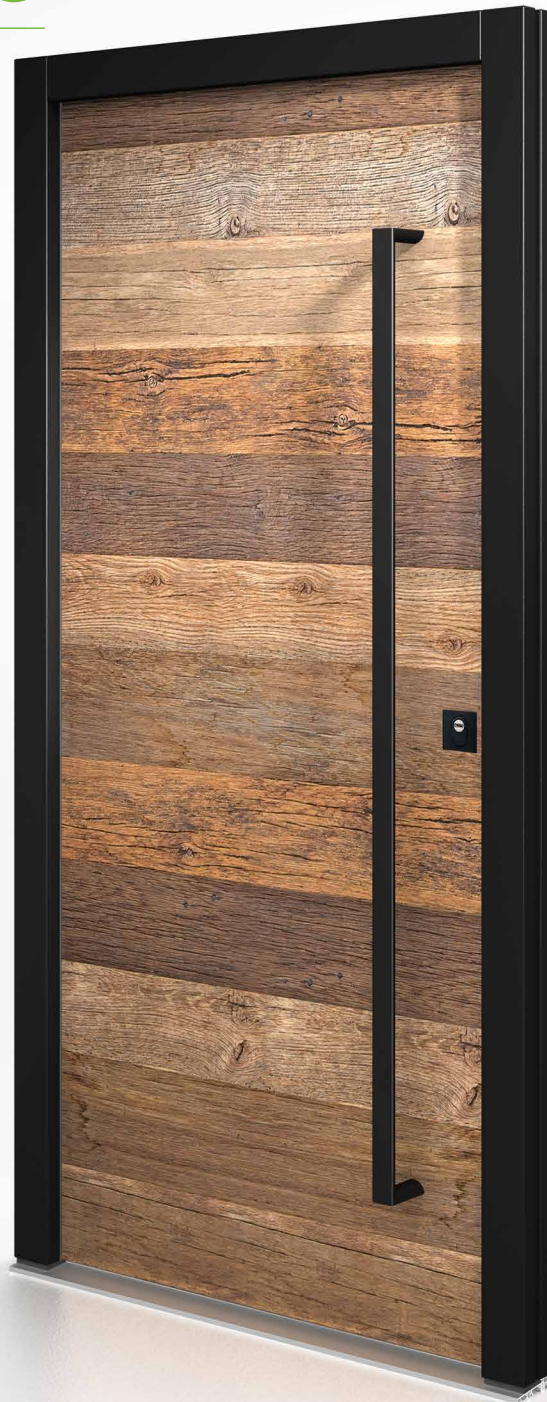

HT A 24-337

Standard Equipment
handle BA 3058
plano-rosette angular BA 3520

*The door leaves are unique,
extreme colour deviations can
occur due to the raw material*

NATURAL, RUSTIC, ORIGINAL

Feel the breath of past centuries: if this entrance door could tell stories! It would certainly be interesting to learn where this oak was once planted, how it survived the wars and what was built and carpentered from its wood.

Standard equipment

*automatic-lock with daytime function | roller hinges, deep black | frame wood type oak, colour RAL 9005 jet black
door leaf outside oak old wood | door leaf inside oak knotty cross veneered brushed | handle and rosettes freely selectable*



please consider, we recommend to install the door only in a protected area for example recessed or roofed or porched in order to avoid a direct weathering through rain or sunlight!



RC 2
standard

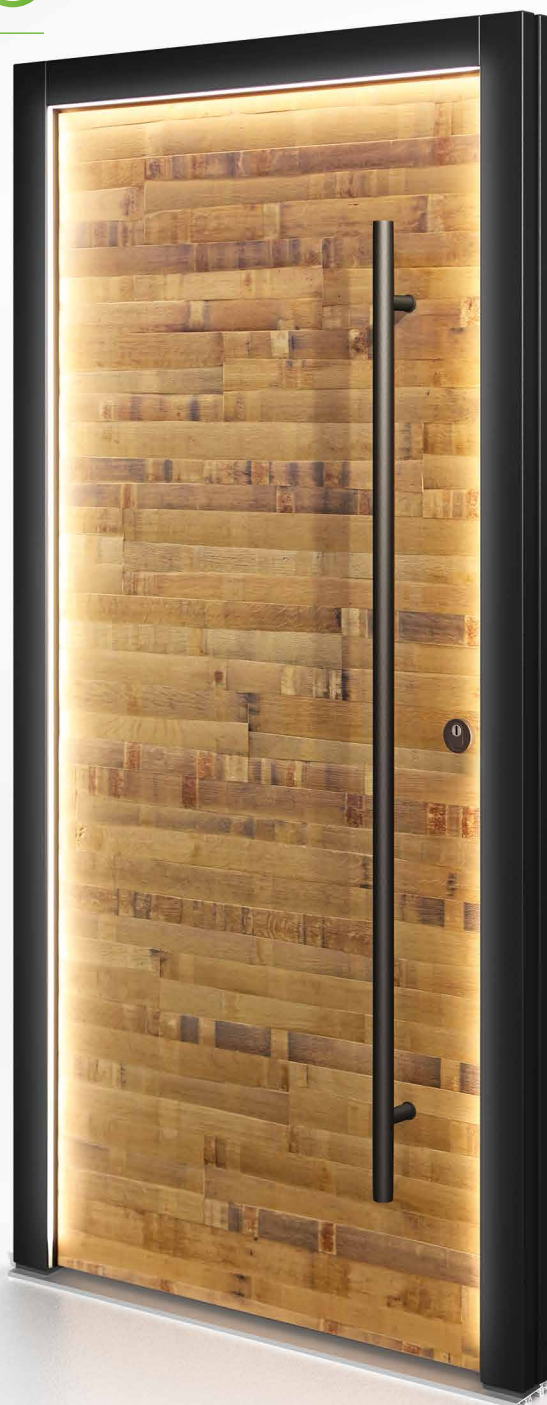

HT A 24-338

Standard Equipment
handle BA 3062
round rosette BA 3518
LED lighting

*The door leaves are unique,
extreme colour deviations can
occur due to the raw material*

UNMISTAKABLE APPEARANCE

Aged from wine: the entrance door „barrel oak“, classic craftsman art translated in a modern way. A unique entrance door with unmistakable appearance for discerning builders with a faible for the special.

Standard equipment

automatic-lock with daytime function | roller hinges, deep black | frame wood type oak, colour RAL 9005 jet black | door leaf outside barrel oak | door leaf inside look OEL 27-10 knotty cross veneered | round rosette BA 3518 | handle freely selectable



HT A 24-338 frame wood type oak, colour RAL9005 jet black | door leaf outside barrel oak | system HT 3-82 handle BA 3058 | round rosette BA 3518 | glazing Iso light

please consider, we recommend to install the door only in a protected area for example recessed or roofed or porched in order to avoid a direct weathering through rain or sunlight!

PREMIUM+

HT A 24-350

Standard Equipment / handle BA 3061
plano-rosette angular BA 3520



HT A 24-351

Standard Equipment / handle BA 3060
plano-rosette angular BA 3520

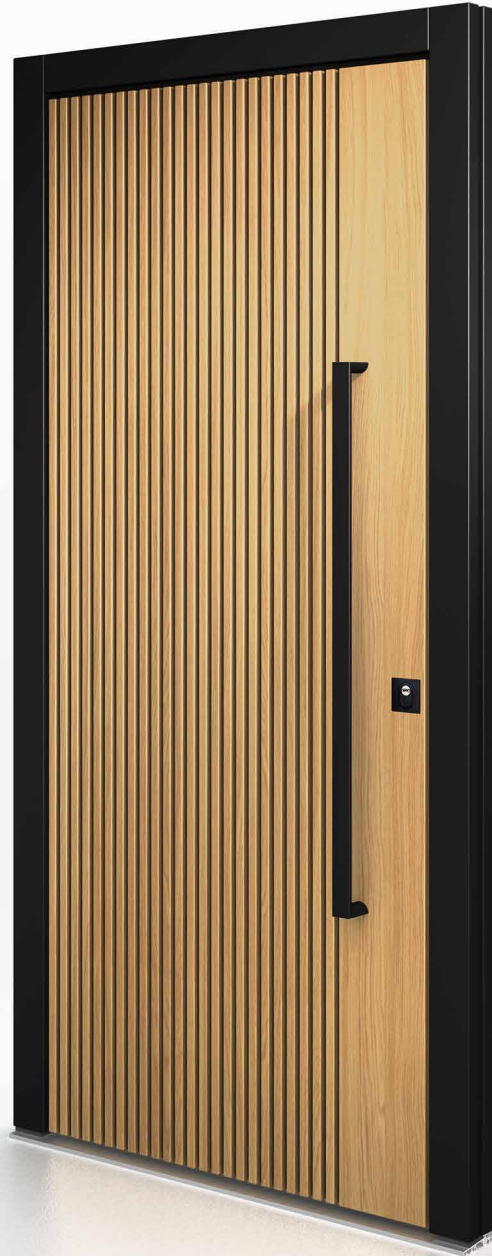

DO YOU LOVE THE EXTRAORDINARY?

Our latest entrance door model is a perfect symbiosis of tradition and modernity, comfort and security. The deep black frame elegantly accentuates the narrow oak mouldings. elegantly accentuated. The sophisticated technology is integrated in the door leaf.

Standard equipment



RC 2
standard

automatic-lock with daytime function | roller hinges, deep black | frame wood type oak, colour RAL 9005 jet black
door leaf outside oak OEL-27-10 | door leaf inside oak OEL-27-10 lengthwise | plano-rosette angular BA 3520 | handle freely selectable

HT A 24-350 INTERIOR VIEW
Oak OEL-27-10 veneered lengthwise



please consider, we recommend to install the door only in a protected area for example recessed or roofed or porched in order to avoid a direct weathering through rain or sunlight!

PREMIUM

NATURAL WOOD SURFACES

The sash of the following entrance doors can be produced in oak or larch. The cross veneer is executed brushed. The colour differences and rough branches are deliberately emphasized. The veneer of the larch is much more knotty and lively like that of the oak. The expression of the individual veneers can nevertheless vary. The frame is executed in a covering shade, so that on the one hand the traditional and on the other hand modern look of the door comes into its own. Since the top coat on the door leaf has only a very low pigmentation, a constructive weather protection of the door is necessary.

These entrance doors can be individually designed with the following wood surfaces:

HT A 24-327 | HT A 24-328 | HT A 24-329 | HT A 24-331





LARCH KNOTTY
brushed bright



LARCH KNOTTY
brushed dark



NEW

OAK KNOTTY
brushed OEL-27-10



OAK KNOTTY
brushed dark



OAK KNOTTY
brushed bright

PREMIUM



RC 2
standard

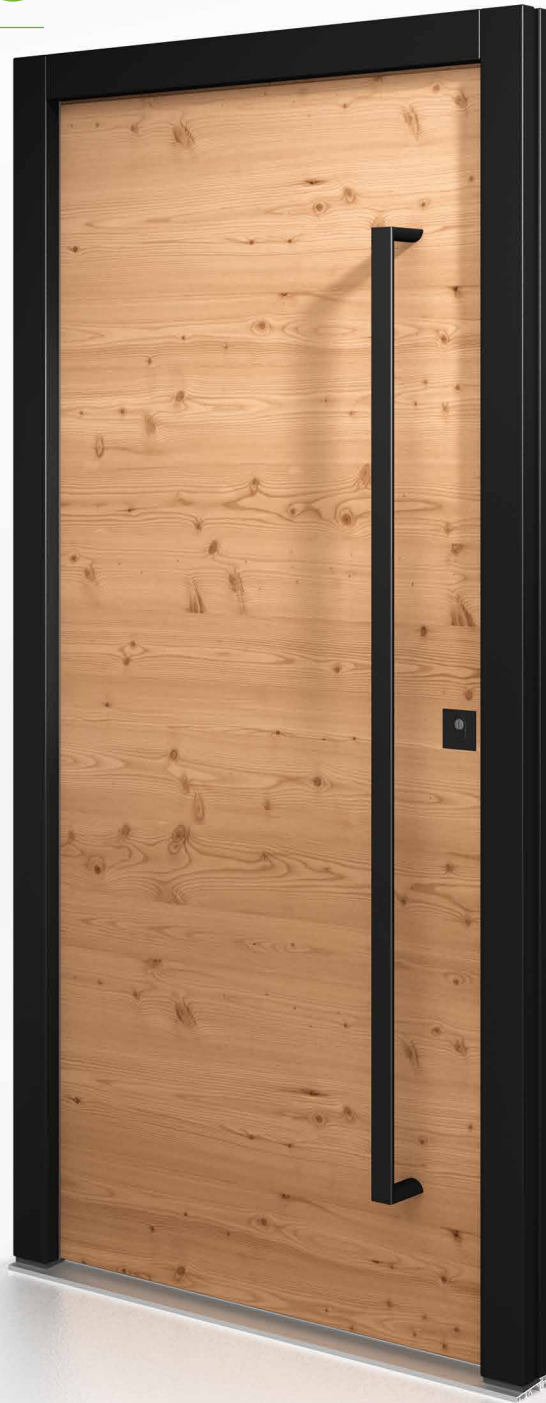

HT A 24-327

door leaf larch brushed light
frame wood type meranti,
colour RAL 9005 jet black
handle BA 3058
plano-rosette angular BA 3520

*Please consider the door
contains optional equipment*

Standard equipment



stainless
steel
standard

automatic-lock with daytime function | roller hinges, silver | frame colour, according to colour chart | door leaf cross veneered, type of wood and colour please see page 13 | handle in stainless steel freely selectable | rosette "round" BA 3502



RC 2
standard

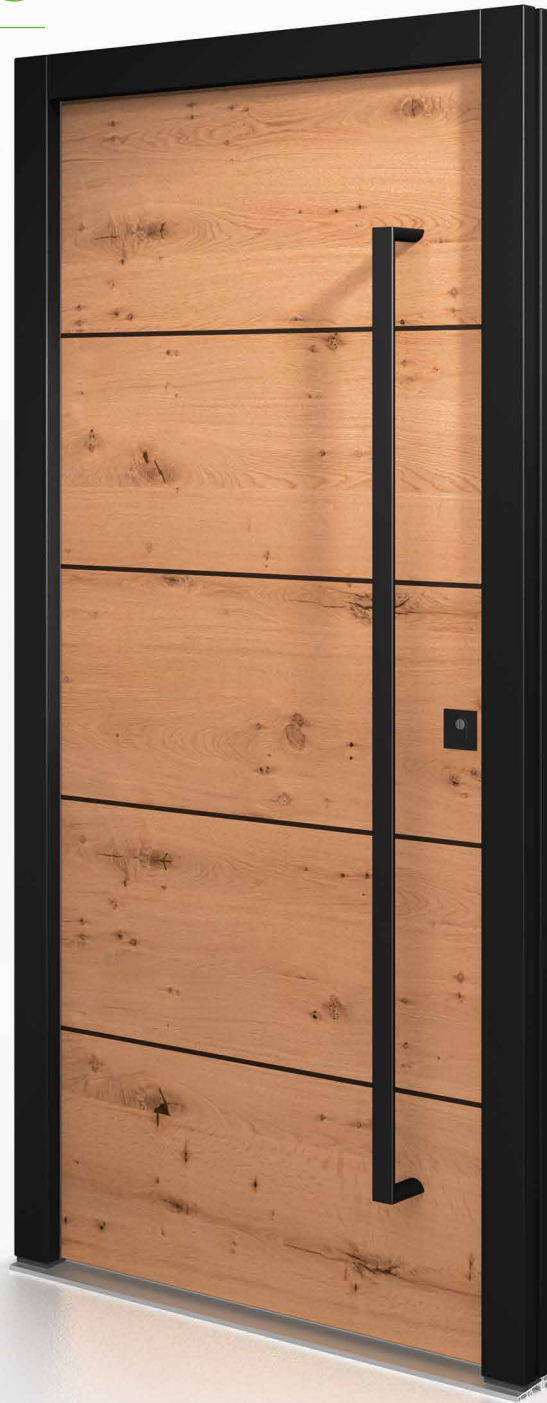

HT A 24-328

door leaf oak brushed light
frame wood type meranti,
colour RAL 9005 jet black
handle BA 3058
plano-rosette angular BA 3520
jet black pilaster stripes

*Please consider the door
contains optional equipment*

Standard equipment



stainless
steel
standard

automatic-lock with daytime function | roller hinges, silver | frame colour, according to colour chart | door leaf cross veneered, type of wood and colour please see page 13 | handle in stainless steel freely selectable | rosette "round" BA 3502 | pilaster stripes in stainless steel

PREMIUM



RC 2
available

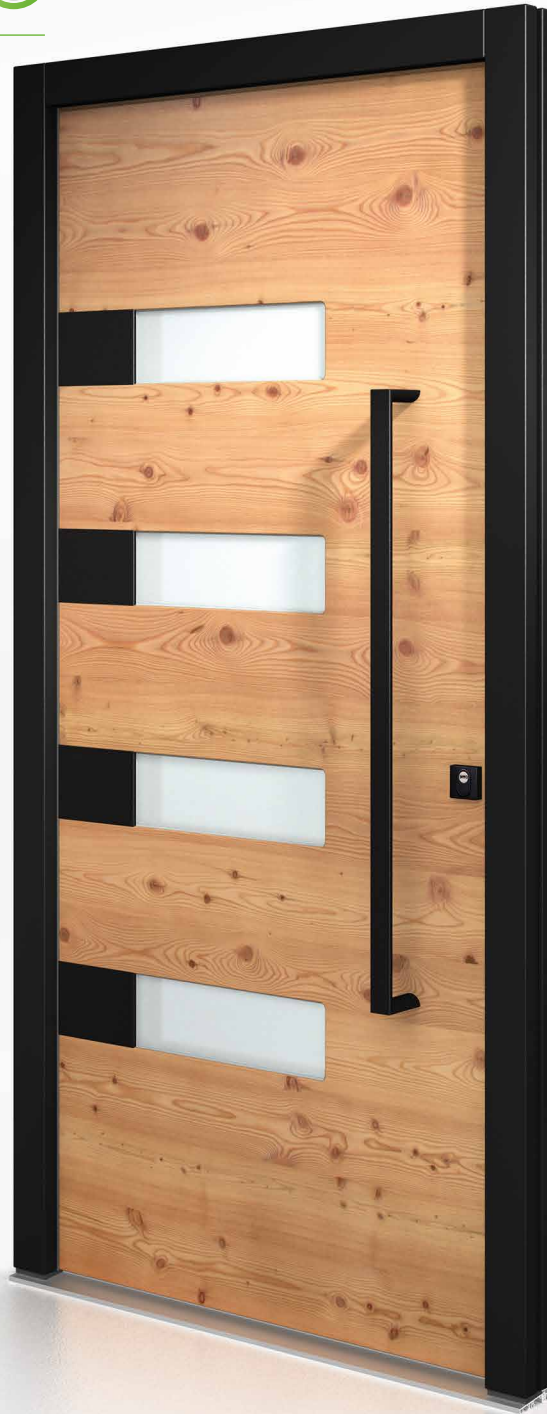

HT A 24-329

door leaf larch brushed light
frame wood type meranti,
colour RAL 9005 jet black
glazing satinato white
handle BA 3060
rosette "angular" BA 3521
jet black applications

*Please consider the door
contains optional equipment*

Standard equipment



stainless
steel
standard

automatic-lock with daytime function | roller hinges, silver | frame colour, according to colour chart | door leaf cross veneered, type of wood and colour please see page 13 | handle in stainless steel freely selectable | rosette "round" BA 3502 | applications in stainless steel



RC 2
available

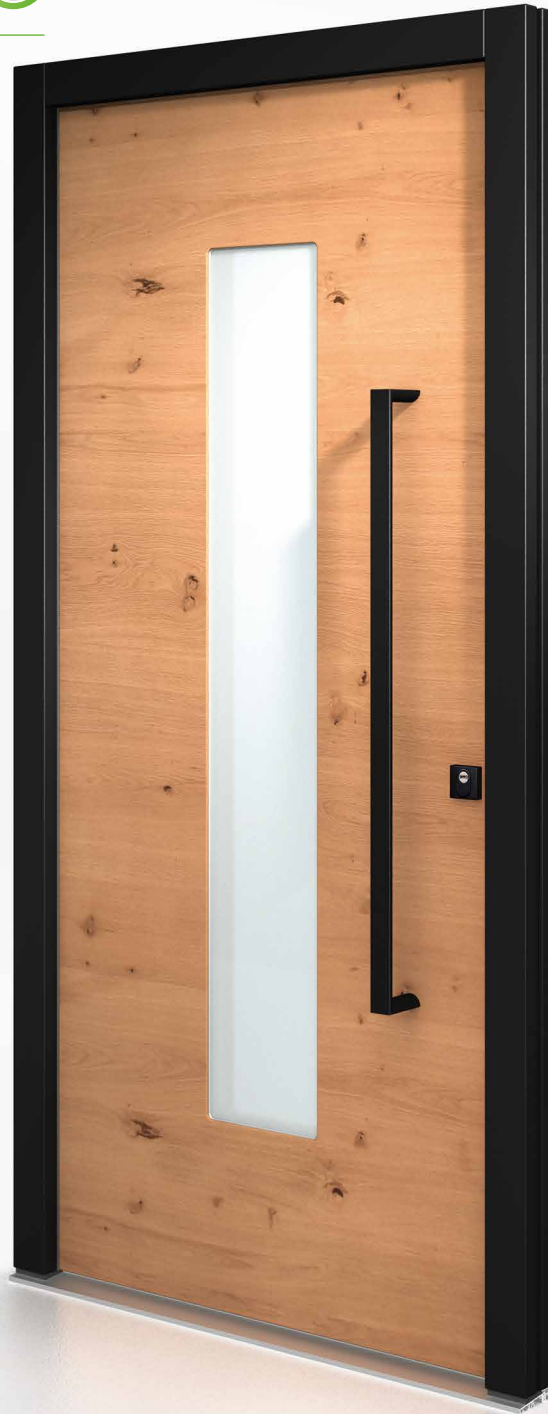

HT A 24-331

door leaf oak brushed light
frame wood type meranti,
colour RAL 9005 jet black
glazing satinato white
handle BA 3060
rosette "angular" BA 3521

*Please consider the door
contains optional equipment*

Standard equipment



stainless
steel
standard

automatic-lock with daytime function | roller hinges, silver | frame colour, according to colour chart | door leaf cross veneered, type of wood and colour please see page 13 | handle in stainless steel freely selectable | rosette "round" BA 3502

PREMIUM

EQUIPMENT
ALSO AVAILABLE IN
JET BLACK



HT A 24-301

wood type pine, colour NCS-S-1500-N
long plate 507 H | glazing satinato white



HT A 24-316

wood type pine, colour NCS-S-1500-N
long plate 507 H | glazing satinato white



HT A 24-333

wood type pine, colour NCS-S-5005-Y20R
long plate 507 H | glazing satinato white



HT A 24-334

wood type pine, colour NCS-S-5005-Y20R
long plate 507 H | glazing satinato white
glued dividers



PREMIUM

EQUIPMENT
ALSO AVAILABLE IN
STAINLESS STEEL



HT A 24-307

wood type pine, colour NCS-S-1500-N
glazing satinato white | grooves
handle BA 3063 | round rosette BA 3518



HT A 24-311

wood type pine, colour NCS-S-1500-N
glazing satinato white | grooves
handle BA 3063 | round rosette BA 3518

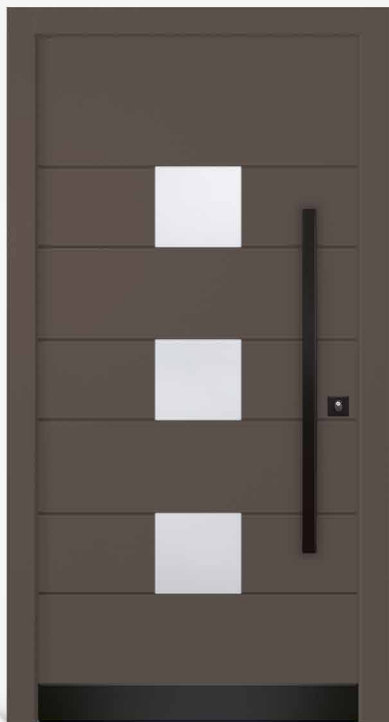

HT A 24-318

wood type meranti, colour NCS-S-7005-Y50R
glazing satinato white | handle BA 3060 | plano-rosette
"angular" BA 3520 | grooves | jet black base plate



HT A 24-325

wood type meranti, colour NCS-S-7005-Y50R
glazing satinato white | handle BA 3063
rosette "round" BA 3518 | grooves

HT A 24-318 wood type pine, colour RAL9016 traffic white | grooves
handle BA 3060 | plano-rosette BA 3520 | glazing satinato white



PREMIUM



HT A 24-302

wood type spruce, colour NCS-S-5005-Y20R
long plate 507 H | glazing satinato white
glued dividers



HT A 24-305

wood type spruce, colour NCS-S-5005-Y20R
handle BA 3009 | rosette "round" BA 3502
stainless steel base plate

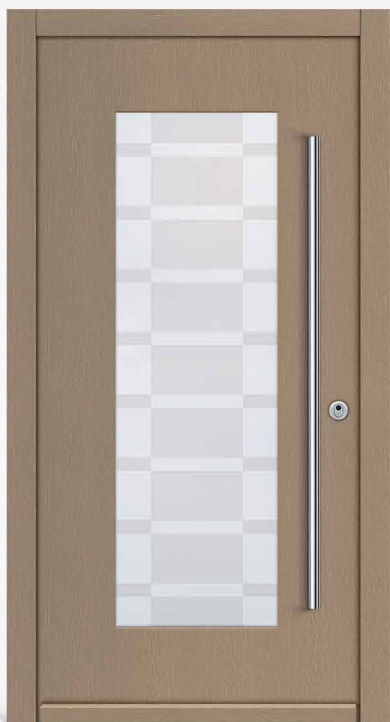

HT A 24-321

wood type spruce, colour NCS-S-5005-Y20R
handle BA 3009 | rosette "round" BA 3502
glass partially sandblasted



HT A 24-335

wood type spruce, colour NCS-S-5005-Y20R
handle BA 3009 | rosette "round" BA 3502
grooves

BASIC

**ALL MODELS
ONLY WITH THE SHOWN HANDLES
OR LONG PLATES AVAILABLE**



HT A 24-340

wood type pine, colour NCS-S-5005-Y20R
glazing satinato white | handle BA 3066, 1000 mm
rosette "round" BA 3502



HT A 24-341

wood type pine, colour NCS-S-5005-Y20R
glazing satinato white | handle BA 3066, 1000 mm
rosette "round" BA 3502



HT A 24-342

wood type pine, colour NCS-S-5005-Y20R
glazing satinato white | handle BA 3066, 1000 mm
rosette "round" BA 3502



HT A 24-343

wood type pine, colour NCS-S-5005-Y20R
glazing satinato white | handle BA 3066, 1000 mm
rosette "round" BA 3502

WOOD TYPES & COLOURS



PINE | SPRUCE
LARCH | OAK
LAS-12-09



PINE | SPRUCE
LARCH | OAK
LAS-16-09



PINE | SPRUCE
LARCH | OAK
LAS-19-03



PINE | SPRUCE
LARCH | OAK
LAS-18-02



PINE | SPRUCE | MERANTI
LARCH | OAK
LAS-40-02



PINE | SPRUCE | MERANTI
LARCH | OAK
LAS-31-01



PINE | SPRUCE | MERANTI
LARCH | OAK
SIK CN.01.55*
(replacement for glaze
LAS-44-14)



PINE | SPRUCE | MERANTI
LARCH | OAK
NCS-S-6020-Y30R*
(replacement for glaze
LAS-43-13)



SPRUCE | MERANTI
OAK
SIK E3.16.28*
(replacement for glaze
LAS-45-13)



SPRUCE | MERANTI
OAK
NCS-S-7502-Y*
(replacement for glaze
LAS-46-13)



SPRUCE
SIK K2.05.25*
(replacement for glaze
LAS-29-13)



SPRUCE
LAS-30-12

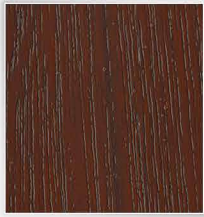

MERANTI
OAK
LAS-32-01



MERANTI
OAK
LAS-33-01



MERANTI
OAK
LAS-35-08



MERANTI
OAK
NCS-S-7005-Y50R

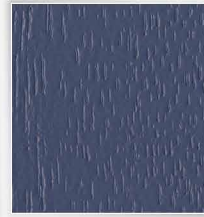

MERANTI
OAK
NCS-S-6020-R80B



MERANTI
OAK
NCS-S-8005-R80B



PINE | SPRUCE | MERANTI
LARCH | OAK
NCS-S-1500-N



PINE | SPRUCE | MERANTI
LARCH | OAK
NCS-S-2005-Y20R



PINE | SPRUCE | MERANTI
LARCH | OAK
NCS-S-5005-Y20R



PINE | SPRUCE | MERANTI
LARCH | OAK
NCS-S-5020-G30Y

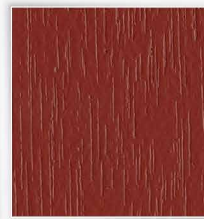

MERANTI
OAK
NCS-S-5040-Y90R



PINE | SPRUCE | MERANTI
LARCH | OAK
RAL-9016 traffic white

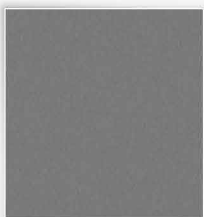

SPRUCE | MERANTI
OAK
RAL-7037 dusty grey



MERANTI
OAK
RAL-7015 slate grey

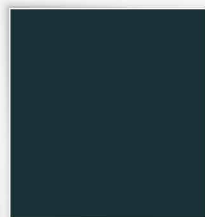

MERANTI
OAK
RAL-7016 anthracite grey



MERANTI
OAK
RAL-6009 moss green

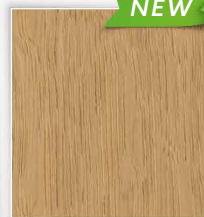

PINE | SPRUCE
LARCH | OAK
OEL-27-10



PINE | SPRUCE
LARCH | OAK
OEL-28-11

GLAZING

To make your new front door even more individual, we offer special glasses for you to choose from. In addition to Iso light, we also offer various ornamental glass types. Or would you prefer Satinato white with a clear edge? Very elegant!



SATINATO WHITE*



CHINCHILLA WHITE*



MASTERCARRE WHITE*



SATINATO WITH CLEAR EDGE



SILVIT WHITE



GOTHIK WHITE



MADRAS PAVE WHITE



MADRAS UADI WHITE



BAROCK WHITE



MIRROR ON THE INSIDE

All doors without glass cutout are perfectly suitable for designing with a large mirror (approx. 30 cm wide). This is a decorative as well as practical design and changes the design in the entrance area.

The following doors are available with mirror:

HT A 24-305 | HT A 24-327 | HT A 24-328 | HT A 24-335
HT A 24-337 | HT A 24-338 | HT A 24-350 | HT A 24-351

* BASIC entrance doors are only available with the marked* glazing

HANDLE BARS



HANDLE BAR HALF-ROUND

material: stainless steel
dimension and type:

- 1500 mm - BA 3028
- 1300 mm - BA 3027
- 1000 mm - BA 3026
- 800 mm - BA 3025



NOTE

For **PREMIUM** and **PREMIUM+** entrance doors you can choose between these handle bars

HANDLE BAR ROUND

material: stainless steel
dimension and type:

- 1500 mm - BA 3012
- 1300 mm - BA 3009
- 1000 mm - BA 3024
- 800 mm - BA 3023



KNOB ROUND

material: stainless steel
type: BA 3006

LONG PLATES & BASE PLATE



LONG PLATE

material: stainless steel
type: BA 3510



LONG PLATE

material: steelgrey
type: 507 H



BASE PLATE

material: stainless steel

The following doors are only available with **LONG PLATE** BA 3510, BA 3511 or 507 H:
HT A 24-301 | HT A 24-302 | HT A 24-316 | HT A 24-333 | HT A 24-334

The following doors are available with **BASE PLATE**:
HT A 24-307 | HT A 24-311 | HT A 24-318 | HT A 24-321 | HT A 24-325
HT A 24-327 | HT A 24-328 | HT A 24-329 | HT A 24-331 | HT A 24-335

INTERIOR HANDLES & EXTERIOR ROSETTES

PREMIUM and **BASIC** front doors are standardly equipped with stainless steel fittings and interior handle BA 3503. On request, a handle can be selected on the outside instead of the handle bar. The outside lever handle is identical with the inside lever handle. You will receive 5 keys in the standard.



INTERIOR HANDLE ROUND

cylinder cover: rosette "round"
material: stainless steel
type: BA 3502



INTERIOR HANDLE ANGULAR

cylinder cover: rosette "angular"
material: stainless steel
type: BA 3506



PROFILE CYLINDER

with drilling protection
and 5 reversible keys



OUTSIDE PLANO-ROSETTE ROUND

with interior handle "round"
material: stainless steel
type: BA 3522



OUTSIDE PLANO-ROSETTE ANGULAR

with interior handle "angular"
material: stainless steel
type: BA 3523

your possibilities

BLACK EQUIPMENT

Black MAGIC

Fully on trend:

Accessories in an elegant very intense black. Mysterious, traditional and fascinating.

Magical forces captivate your visitors and convey an enchanting, sparkling atmosphere of well-being.

Surprise family, friends and acquaintances with a high quality entrance door made especially for you, including the most state-of-the-art technology.

Made with decades of experience.

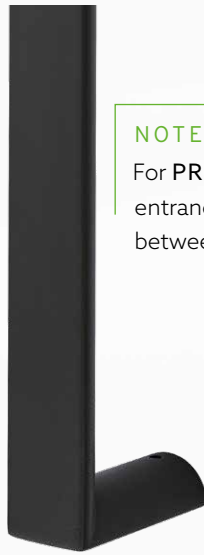

NOTE

For PREMIUM and PREMIUM+ entrance doors you can choose between these handle bars



HANDLE BAR HALF-ROUND

dimension and type:

- 1500 mm - BA 3058
- 1300 mm - BA 3059
- 1000 mm - BA 3060
- 800 mm - BA 3061

HANDLE BAR ROUND

dimension and type:

- 1500 mm - BA 3062
- 1300 mm - BA 3063
- 1000 mm - BA 3064
- 800 mm - BA 3065



OUTSIDE

INTERIOR HANDLE ROUND

cylinder cover: rosette "round"
type: BA 3518



OUTSIDE

INTERIOR HANDLE ANGULAR

cylinder cover: rosette "angular"
type: BA 3521



OUTSIDE

LONG PLATE

type: BA 3511



INSIDE

OUTSIDE PLANO-ROSETTE ROUND

with interior handle "round"
type: BA 3519



INSIDE

OUTSIDE PLANO-ROSETTE ANGULAR

with interior handle "angular"
type: BA 3520



FINGERPRINT



ROLLER HINGES
3 per entrance door



FRAME COLOUR
RAL 9005 jet black*



BASE PLATE



APPLICATIONS

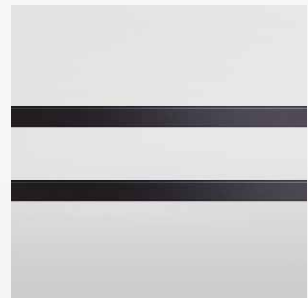

PILASTER STRIPES

* The colour RAL 9005 jet black is only possible in meranti or oak.

SPECIAL EQUIPMENT

ACCESS OPTIONS

All doors are equipped as standard with an automatic lock (without E-opener).

By pulling the door, the latch bolts at the top and bottom of the door automatically move 20 mm into the bolting bar. As a result, the door is always locked - without locking with the key. A day trap (also called snapper or latch) is also integrated in the lock, however, the automatic locking must be deactivated for use.

1 E-OPENER

Electric door opener - for using, the automatic lock has to be deactivated manually. The E-opener is integrated in the face plate.

- ✓ Easy opening of the door by actuation of e.g. the domestic intercom system
- ✓ No need to walk to the door

2 AUTOMATIC LOCK WITH M-OPENER

Door opener with motor-driven release - By pulling the door closed the multipoint lock will be activated without locking it. Releasing is done by pressing the handle or for instance by a domestic intercom system. Electrical opening options such as fingerprint or domestic intercom system are overridden by manual relocking.

- ✓ Maximum security without locking
- ✓ The automatic and the motorised locking complement each other
- ✓ Ideal for access system in single and multi-family houses

3 FULL MOTORIZED LOCK

Opening and closing is motorized - as if by magic. As soon as the door falls into the lock, the lock independently closed, without any manual closing. The opening of the door is comfortably motorized via door opener the intercom system or via access systems.

- ✓ Maximum comfort and security
- ✓ Increased tightness
- ✓ Panic function as standard, opening the door from inside is always guaranteed

FULLY CONCEALED HINGES

You have the possibility to upgrade all front doors with concealed hinges.

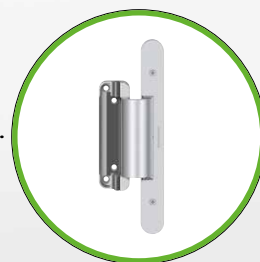

FINGERPRINT

KEYLESS ACCESS

Smart access with fingerprint because intelligent building utilisation begins directly at your new entrance door. While keys, codes or cards can be forgotten, lost or stolen your finger is always with you. But a fingerprint is even more - it gives the entrance door with new features a smart upgrade! This creates more comfort and safety in everyday life and for the whole family.



YOUR FINGER AS A KEY



HIGHEST SECURITY



PUSH-NOTIFICATIONS



PERSONALISED TIME FRAMES



SMART REMOTE OPENING



1 FINGERPRINT "STAINLESS STEEL" FOR THE DOOR LEAF FINGERPRINT "BLACK" FOR THE DOOR LEAF

- ✓ 4-segmental luminous ring for visual signalling
- ✓ with provider-app for smart functions
- ✓ single-user management included as standard
- ✓ access system is managed via smartphone or tablet



2 FINGERPRINT "STAINLESS STEEL" WITH HANDLE BAR FINGERPRINT "BLACK" WITH HANDLE BAR

- ✓ 4-segmental luminous ring for visual signalling
- ✓ with provider-app for smart functions
- ✓ single-user management included as standard
- ✓ access system is managed via smartphone or tablet

"stainless steel" half-round: 1300 mm – BA 3072 or 1500 mm – BA 3073
"black" half-round: 1300 mm – BA 3074 or 1500 mm – BA 3075

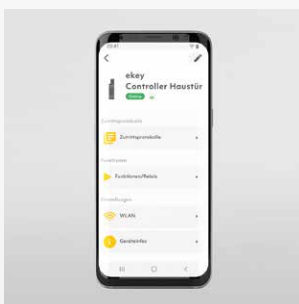

MANAGE FINGERPRINT-SYSTEM WITH THE PROVIDER-APP

The app as a management centre, where you can assign roles and authorisations for family, friends or service providers, among other things.

Push notifications let users know that their loved ones have arrived home safely. The front door can also be opened remotely. The connection to the Amazon Alexa voice assistant provides additional convenience at the front door - your practical everyday helper!

SYSTEM REQUIREMENTS

The fingerprint can only be integrated with a **functioning WLAN** and the corresponding ekey binoyx app. The app can be downloaded via the Play Store or App Store. A smartphone or tablet with the following requirements is necessary for installation and commissioning: Android 9 or higher, iPhone or iPad requires iOS 14.0 or higher.



SAFETY TECHNOLOGY

SECURITY AND SAFETY FOR YOUR HOME

Your new entrance door should be inviting for visitors and deterrent for burglars. First and foremost, it must guarantee safety because burglars choose this way more and more often. Even with the basic equipment we therefore attach great importance to the solid safety mechanism.





SAFETY COMPONENTS

STANDARD EQUIPMENT

- 1 Lock tested corresponding to security class RC 2: when closing the door the latch bolts drive 20 mm into the bolting bar via a magnetic impuls at the top and bottom of the door. Therefore the door is always closed - without re-closing with a key.
- 2 The main bolt can be locked with a key turn - the lever blocks for control purposes, as a child safety lock and for maximum security.
- 3 Continuous bolting bar: protection against prying on the lock side
- 4 Cylinder with drill protection
- 5 5 Interior handle in stainless steel with exterior cylinder cover (ES1-part): serves as a pull protection for the cylinder
- 6 Stable roller conveyor: triple security on the hinge side

ON REQUEST THE PLUS IN SAFETY

- 7 P4A safety glazing: One pane consists of a composite of two panes with integrated security foil. Furthermore, the glazing is glued circumferential with a special adhesive in the glass cut-out. Thus, the glass connection is secured. | Safety execution RC 2 **against surcharge**

The status **RC 2 TESTED** achieve the following front doors

- ✓ Without glass cut-out through standard equipment:
HT A 24-305 | HT A 24-327 | HT A 24-328 | HT A 24-335 | HT A 24-337 | HT A 24-338 | HT A 24-350 | HT A 24-351
- ✓ through the use of an additional P4A protective glazing:
HT A 24-307 | HT A 24-311 | HT A 24-318 | HT A 24-321 | HT A 24-325 | HT A 24-329 | HT A 24-331
- ✓ For front doors of series 3 you can get an RC 2 test certificate as an option | **against surcharge**

TECHNICAL DATA

MATERIAL	wood
SYSTEM	HT 1-82 construction door frame and leaf are profiled or straight HT 2-82 construction door frame and leaf are profiled or straight
GASKETS	2 pieces
GLAZING	triple glazing, with warm edge
WOOD TYPE	pine, spruce, meranti, larch and oak
WOOD SURFACE	4-layer colour application, colours according to KNEER-SÜDFENSTER colour chart
LOCK	multiple locking with daytime function, without E-opener but with day release
CYLINDER	profile cylinder with emergency and danger function, drill protection and 5 keys
HINGES	3 pieces of 3-piece bands (asymmetric band seat)
MAX. SIZE	1150 x 2250 mm frame outer dimension
MIN. SIZE	980 x 1980 mm frame outer dimension

U_D-VALUE HT 1-82 *

MODEL	CATEGORY	U _D -VALUE SPRUCE	U _D -VALUE PINE/MER/LAR	U _D -VALUE OAK
HT A 24-302	PREMIUM	0,96 W/m ² K	1,0 W/m ² K	1,2 W/m ² K
HT A 24-333	PREMIUM	0,91 W/m ² K	0,97 W/m ² K	1,1 W/m ² K
HT A 24-334	PREMIUM	0,91 W/m ² K	0,96 W/m ² K	1,1 W/m ² K
HT A 24-340	BASIC	0,90 W/m ² K	0,95 W/m ² K	1,1 W/m ² K
HT A 24-341	BASIC	0,94 W/m ² K	0,98 W/m ² K	1,1 W/m ² K
HT A 24-342	BASIC	0,96 W/m ² K	1,0 W/m ² K	1,2 W/m ² K
HT A 24-343	BASIC	0,98 W/m ² K	1,0 W/m ² K	1,2 W/m ² K

U_D-VALUE HT 2-82 *

MODEL	CATEGORY	U _D -VALUE FICHTE	U _D -VALUE PINE/MER/LAR	U _D -VALUE OAK
HT A 24-301	PREMIUM	0,97 W/m ² K	1,0 W/m ² K	1,2 W/m ² K
HT A 24-316	PREMIUM	0,97 W/m ² K	1,0 W/m ² K	1,2 W/m ² K

HT 1-82

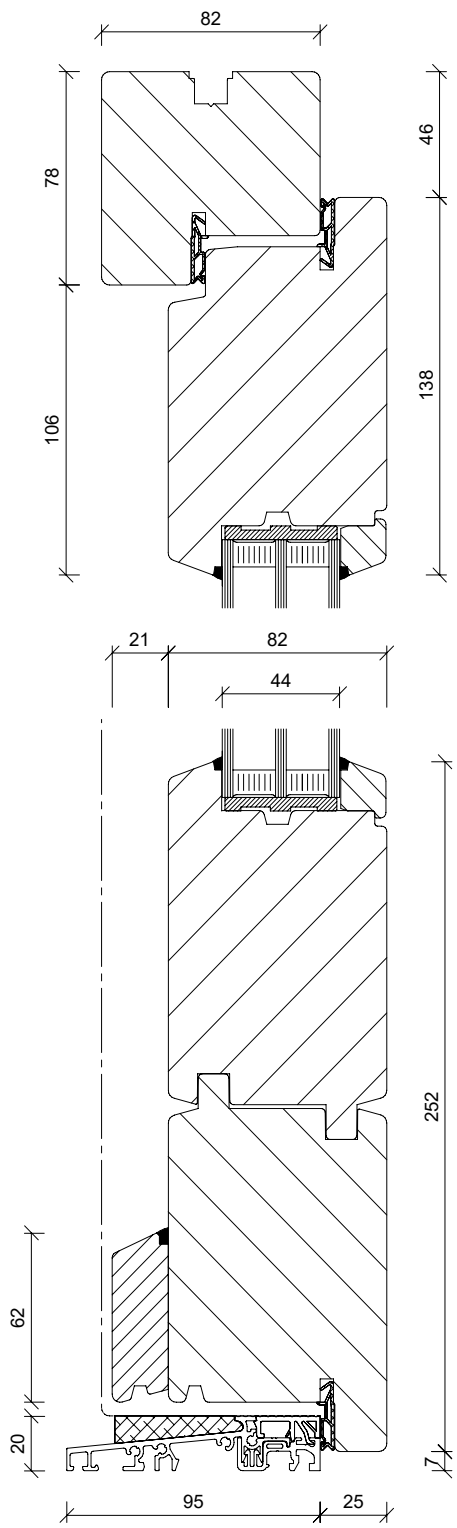

HT 2-82

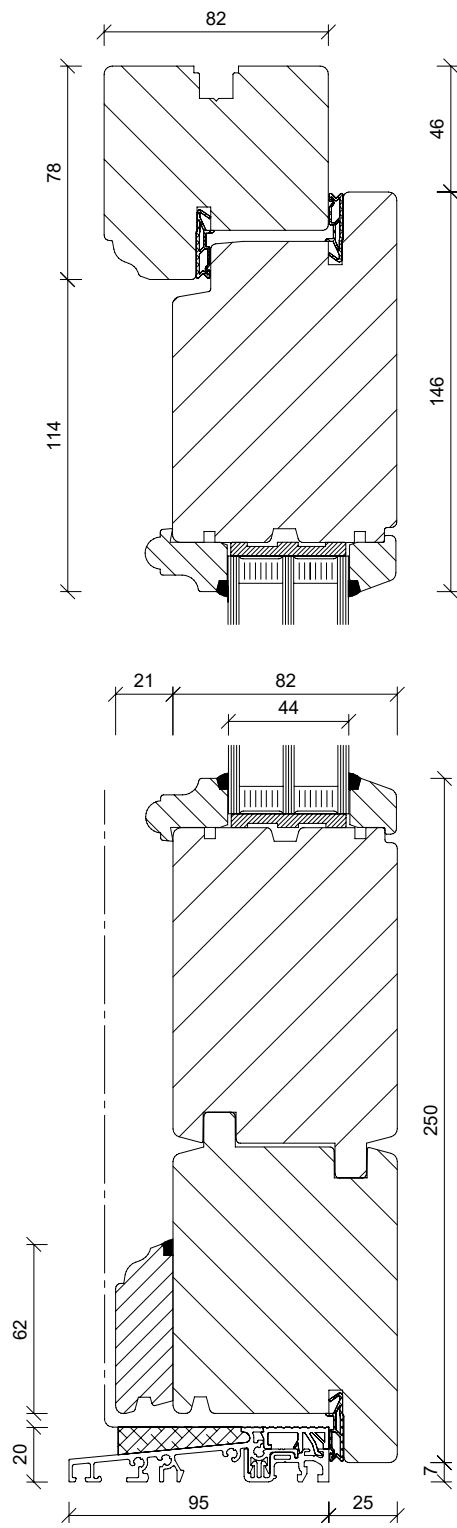

TECHNICAL DATA

MATERIAL	wood
SYSTEM	HT 3-82 full leaf door frame 82 mm, leaf 78 mm
GASKETS	2 pieces
GLAZING	triple glazing, with warm edge
WOOD TYPE	pine, spruce, meranti, larch and oak
WOOD SURFACE	4-layer colour application, colours according to KNEER-SÜDFENSTER colour chart
LOCK	multiple locking with daytime function, without E-opener but with day release
CYLINDER	profile cylinder with emergency and danger function, drill protection and 5 keys
HINGES	3 pieces of 3-piece bands (asymmetric band seat)
MAX. SIZE	1150 x 2250 mm frame outer dimension
MIN. SIZE	980 x 1980 mm frame outer dimension

U_D-VALUE HT 3-82 *

MODEL	CATEGORY	U _D -VALUE SPRUCE	U _D -VALUE PINE/MER/LAR	U _D -VALUE OAK
HT A 24-337	PREMIUM⁺	-	-	1,0 W/m ² K
HT A 24-338	PREMIUM⁺	-	-	1,0 W/m ² K
HT A 24-350	PREMIUM⁺	-	-	1,0 W/m ² K
HT A 24-351	PREMIUM⁺	-	-	1,0 W/m ² K
HT A 24-305	PREMIUM	0,86 W/m ² K	0,90 W/m ² K	1,0 W/m ² K
HT A 24-307	PREMIUM	0,91 W/m ² K	0,96 W/m ² K	1,1 W/m ² K
HT A 24-311	PREMIUM	0,90 W/m ² K	0,95 W/m ² K	1,1 W/m ² K
HT A 24-318	PREMIUM	0,89 W/m ² K	0,94 W/m ² K	1,1 W/m ² K
HT A 24-321	PREMIUM	0,91 W/m ² K	0,96 W/m ² K	1,1 W/m ² K
HT A 24-325	PREMIUM	0,90 W/m ² K	0,95 W/m ² K	1,1 W/m ² K
HT A 24-327	PREMIUM	0,86 W/m ² K	0,90 W/m ² K	1,0 W/m ² K
HT A 24-328	PREMIUM	0,86 W/m ² K	0,90 W/m ² K	1,0 W/m ² K
HT A 24-329	PREMIUM	0,91 W/m ² K	0,95 W/m ² K	1,1 W/m ² K
HT A 24-331	PREMIUM	0,90 W/m ² K	0,95 W/m ² K	1,1 W/m ² K
HT A 24-335	PREMIUM	0,86 W/m ² K	0,90 W/m ² K	1,0 W/m ² K

HT 3-82

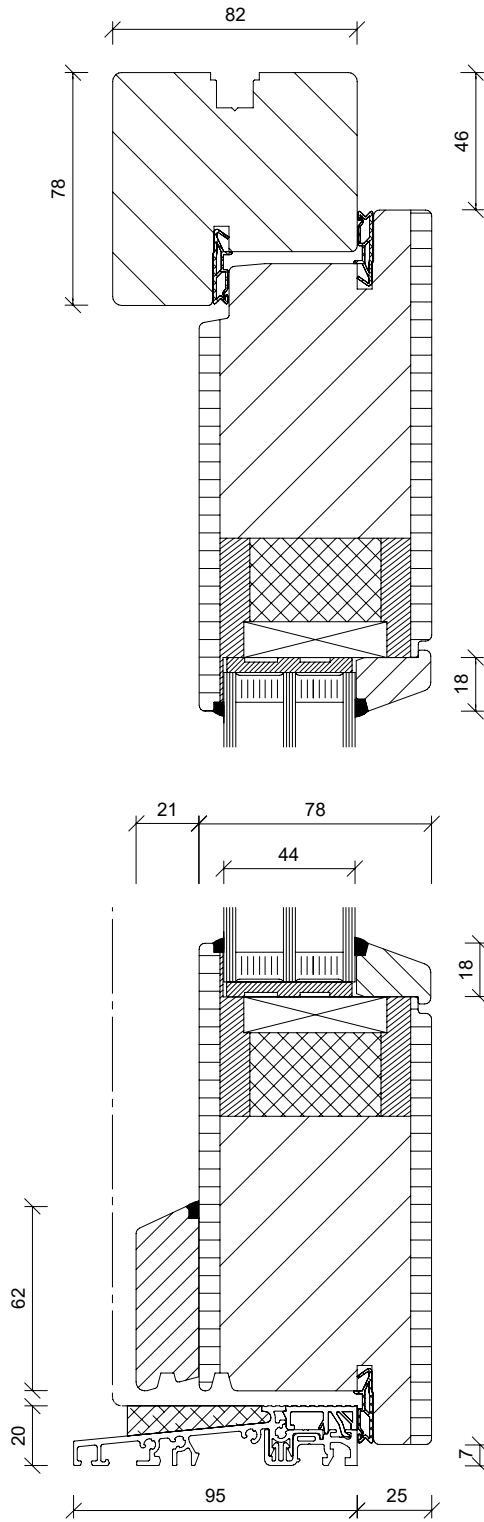

ALSO AVAILABLE

SIDE LIGHTS

ST A 1, ST A 2 and ST A 3 possible

(max. width 910 mm)

Pine, meranti and spruce possible

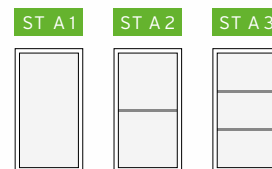

GLAZING

VSG 6 mm for entrance door (one side)

VSG 6 mm for side light (one side)

COLOURS

Entrance door and side light in RAL at choice

Entrance door inside different colour as outside

(one colour shade must be opaque)

Side light inside different colour as outside

(one colour shade must be opaque)

ACCESS OPTIONS

Electric opener

Automatic lock as multipoint locking with M-Opener

SECURITY / MISCELLANEOUS

Safety execution RC 2 for entrance door (tested)

Entrance door with higher security level*

Safety execution RC 2 for side lights (tested)

Mirror on the inside of the entrance door

LED lighting for HT A 24-338

Sandblasted glass with clear edge or clear stripes
(entrance door and/or side light) per door or side light

Entrance door or side light with coloured offset glass
rod outside (covering paint)

NOTE

There might be slight deviations in colour due to printing process.

KNEER · SÜD **FENSTER**

Lived Vision



KNEER GmbH Fenster und Türen

Horst-Kneer-Straße 1
D-72589 Westerheim
phone: +49 (0) 7333 / 83-0
e-Mail: info@kneer.de

SÜD-FENSTERWERK GmbH & Co. Betriebs-KG

Rothenburger Straße 39
D-91625 Schnelldorf
phone: +49 (0) 7950 / 81-0
e-Mail: info@suedfenster.de

SÜD-BAUELEMENTE GmbH

Ludwig-Erhard-Straße 4
D-03238 Massen
phone: +49 (0) 3531 / 799-114
e-Mail: info@suedfenster.de



WWW.KNEER-SUEDFENSTER.DE

Your KNEER-SÜDFENSTER specialized dealer: